

Engineering Standard

Track

CRN CS 215

TRANSIT SPACE

Version 1.4

Issued January, 2021

Owner: Manager Engineering Services
Approved by: M Wright, Principal Track and Civil Engineer
Authorised by: J Zeater, Manager Engineering Services

Disclaimer. This document was prepared for use on the CRN Network only. John Holland Rail Pty Ltd makes no warranties, express or implied, that compliance with the contents of this document shall be sufficient to ensure safe systems or work or operation. It is the document user's sole responsibility to ensure that the copy of the document it is viewing is the current version of the document as in use by JHR. JHR accepts no liability whatsoever in relation to the use of this document by any party, and JHR excludes any liability which arises in any manner by the use of this document.

Copyright. The information in this document is protected by Copyright and no part of this document may be reproduced, altered, stored or transmitted by any person without the prior consent of JHR.

Document control

Revision	Date of Approval	Summary of change
1.0	August, 2011	First Issue. Includes content from the following former RIC standards: C 2101, C 2102, C 2103, C 2104, C 2105, C 2106, C 2108, C 2111
1.1	July, 2013	6.1.1 – Table 1 – Clarification of the 2150mm horizontal clearance that it relates to below rail level only; 7 – Figure 1 and Figure 2–Removal of Trip Arm Infringement; 7.1.4 – Change to reflect requirement for a minimum of 2 Narrow Track Centres signs; 7.3.2 – Table 11 – Correction of Asset code descriptor; 7.4.2 – Table 11 – Changes to match content in CRN CM 215; 9.2 – Table 13 – Reduction of extra lateral clearance for determination of track centre clearances; addition of explanatory note and figure; Appendix 1 – Figure 8 and Table 17 – correction of error and inclusion of approved corridors for Narrow Square RS outline (Includes content from CCW 12/030 and CCW 12/034)
1.2	June, 2016	Various - Changed 'Principal Civil Engineer' to 'Principal Track Civil Engineer'; Rewording for consistency and minor corrections; 2.2 - Corrected standards references; 2.4 - Change Service Requirement" to "Infrastructure Service Requirement"; 4.1 - Added explanation to Structure Gauge types; 7 - Figure 1 – correction of typographical errors; 7.1.3 - Table 8 Change formula to reflect measurement of radius R in mm; 9 - Included reference to rolling stock standard; 11.2.1 - Deleted reference to simplified formula for Centre and End Throw; Appendix 1 - Figure 8 and Table 17 - Inclusion of approved corridors for Narrow Square RS outline Nevertire to Warren 582.100 (includes content of CCW 14/019); Inclusion of approved corridors for Narrow Square RS outline Orange to Dubbo; Inclusion of approved corridors for Narrow Square RS outline The Rock to 553.922 (The Rock ABA)
1.3	July, 2016	Appendix 1 - Figure 8 and Table 17 – Inclusion of Orange to Dubbo and Temora to Griffith as approved corridors for Narrow Container RS outline – ARTC approvals not previously included in error
1.4	January, 2021	See Summary of Changes below

Summary of changes from previous version

Section	Summary of change
Various	Minor formatting and grammar changes throughout; Removal of Intersystem, Out of Gauge Load and NZZA Wagon on CRN;
9	Inclusion of requirement to consult with the Principal Rolling Stock Engineer for alterations to rolling stock outlines
11.2	Removal or duplication of application of centre and end throw
12.2.2	Inclusion of commentary for historical platform height allowance
Appendix 1	Updated for the removal of Intersystem, Out of Gauge Load and NZZA Wagon
Appendix 2	Updated diagrams

Contents

1	Scope and application	4
2	References	4
2.1	Australian and International Standards	4
2.2	CRN documents	4
2.3	Other references	4
2.4	Definitions	4
3	Engineering authority	5
4	Design requirements	5
4.1	Structure Gauge	5
4.2	Infrastructure service requirements	6
4.3	Passenger platforms	6
4.4	Design physical interfaces	6
5	Application	6
6	Minimum infrastructure service requirements	7
6.1	Horizontal	7
6.2	Vertical	8
6.3	Track centres	8
7	Structure gauges	10
7.1	Normal Structure Gauge 1994	10
7.2	General Kinematic Structure Gauge	12
7.3	Platform Kinematic Structure Gauge	13
7.4	Transit space waivers	14
8	Physical interface requirements	15
9	Authorised rolling stock outlines	15
9.1	Dynamic rolling stock allowances	16
9.2	General kinematic displacements	16
10	Track tolerances	17
10.1	Open track	17
10.2	Platforms	18
11	Calculation of kinematic structure gauges	18
11.1	General	18
11.2	Calculation of kinematic envelope	18
11.3	Kinematic track centres	19
12	Calculation of platform kinematic structure gauge	19
12.1	General	19
12.2	Normal platform dimensions	19
13	Reduced track centre signs	22
13.1	Description	22
13.2	Size	22
13.3	Position of signs	22
13.4	Documentation	22
14	Acceptance standards	23
14.1	Construction tolerances at structures (other than platforms)	23
14.2	Construction and maintenance tolerances at platforms	23
Appendix 1	Authorised rolling stock outlines	25
Appendix 2	Rolling stock cross-sections	31
Appendix 3	Definition of Symbols	37

1 Scope and application

This standard establishes requirements for Transit Space design.

Transit Space Standards provide for the safe passage of approved trains by providing:

1. Various levels of structure gauge based on safety considerations, made up of:
 - ~
 - ~ Approved rolling stock and loading profiles
 - ~ Track tolerances
 - ~ Vehicle displacements
 - ~ Allowances for curvature and superelevation
 - ~ A safety clearance margin.
2. Minimum infrastructure service requirements for maintainability (e.g. drainage, mechanised maintenance, service access and increased track centre requirements).

This standard applies to all Country Regional Network (CRN) infrastructure.

2 References

2.1 Australian and International Standards

Nil

2.2 CRN documents

CRN RS 008 - General Interface Requirements for Rolling Stock

CRN CS 210 - Track Geometry and Stability

CRN CP 213 - Trackside Signs

CRN Network Rules

2.3 Other references

Nil

2.4 Definitions

Corridor Transit Space Strategy:	Operating parameters for a specified line, incorporating business and infrastructure service requirements.
Infrastructure Service Requirement:	The clearance beyond the Safety Clearance Margin which enables defined service tasks to be undertaken.
Kinematic Envelope	A two-dimensional cross-sectional representation of the swept path of a particular vehicle.
Kinematic Outline	The cross-sectional envelope produced by a rail vehicle or that of an authorised static rolling-stock outline, including any dynamic displacements.
Rolling stock	A two-dimensional shape representing the cross-section of a rail vehicle

Outline	or that of an authorised rail vehicle outline.
Rolling stock	Any train, vehicle, track machine or piece of equipment, which is expected to be on a track and guided by the rails.
Rolling stock Tolerances	Accepted manufacturing discrepancies which may cause a vehicle to exceed its designed dimensional shape.
Rolling Stock Displacements	The maximum possible/allowable dynamic displacements of the rolling stock from the track centreline, perpendicular to the rail plane. These displacements are described in terms of lateral, vertical and body roll.
Safety Clearance Margin:	The defined clearance beyond the kinematic envelope necessary for safe operation using specified track tolerances and rolling stock displacements.
Special Loads/Profiles:	Vehicle/loading envelopes which infringe approved rolling stock outlines.
Structure Gauge	A defined envelope around the track, within which no structure is permitted.
Swept Path	The volumetric shape generated by the lateral displacement (throw) of a vehicle body centre and ends relative to the track centreline, during curve negotiation for an applicable vehicle or that of the Standard Rolling Stock Outline proportions.
Track Tolerances	The possible displacements of the track from its design track position and gauge.

Symbols used in this standard are defined in Appendix 3.

3 Engineering authority

Design and selection of infrastructure detailed in this standard for use on the CRN may only be undertaken by persons who have been granted appropriate Engineering Authority by the Principal Track and Civil Engineer.

4 Design requirements

The design, construction and maintenance of all new track, structures and rolling stock, and the maintenance of existing assets shall comply with the following requirements.

4.1 Structure Gauge

All clearances between track and structures, and other tracks, shall meet the requirements of one of the following Structure Gauges:

- Normal Structure Gauge 1994 (easier application, resulting in a conservative outline)
- General Kinematic Structure Gauge (for use when clearances are more restricted than above).

In ALL circumstances where these requirements cannot be met, design approval of the Principal Track and Civil Engineer is required. Approval shall be granted by the issuing of a Transit Waiver in accordance with the requirements of Section 7.4.

Where major works are being planned that will result in permanent or long-term constraints on clearances (e.g. road overbridges, tunnels etc.), consideration shall be given to long term corridor strategies.

Where infrastructure is being constructed to meet transit space requirements that will be imposed by the future introduction of larger (wider and/or higher) rolling stock, care is required to minimise the impact of larger than standard clearances (e.g. platform gaps).

The applicability of the Structure Gauges is outlined in Section 5.

4.2 Infrastructure service requirements

The Principal Track and Civil Engineer shall specify minimum service requirements for the situations listed in Section 6 based on long-term corridor strategies. The Minimum Service Requirements shall not infringe the General Kinematic Structure Gauge.

In the absence of any specific requirements, the default minimum dimensions listed in Section 6 shall be adopted.

Any new work or major reconstruction that results in a structure infringing the Minimum Service Requirements but complying with the General Kinematic Structure Gauge, requires the approval of the Civil Maintenance Engineer.

Any existing location or structure, or minor work of a non-permanent nature carried out on, or near an existing location or structure, which infringes the Minimum Service Requirements, but complies with the General Kinematic Structure Gauge, requires no authorisation.

4.3 Passenger platforms

Platforms are a critical interface with track. By definition they infringe structure gauge. Design of transit-space aspects of platforms shall be in accordance with the requirements of Section 12.

4.4 Design physical interfaces

Approved trackside structures and items of equipment, such as rail lubricator actuators, automatic wagon door openers, buffer stops, check rails etc., are essential for system operation and require a physical interface between rolling stock and infrastructure. These items are permitted to be within the structure gauge. Approved items are detailed in Section 12.

Any item of equipment that is required to physically interface with rolling stock, other than those detailed in Section 12, requires the approval of the Principal Track and Civil Engineer.

5 Application

The different structure gauges shall be applied as follows. Each allows tighter clearances than the preceding level, with a corresponding increase in the complexity of the calculation, level of authorisation required, the degree of risk imposed, or the impact of restrictions on the maintainer or operator.

1. Normal Structure Gauge 1994 (including Normal Track Centres)

Applicable to all CRN tracks where clearance is available. It provides for ease of use under most circumstances for new construction and includes appropriate infrastructure service requirements as detailed in Section 6. No restrictions are placed on rolling stock operation on corridors carrying any authorised rolling stock outline. It does not require determination of kinematic envelopes.

Calculation of the Normal Structure Gauge 1994 is detailed in Section 7.1.

2. General Kinematic Structure Gauge.

Applicable to all CRN tracks where clearance is available, in circumstances where reduced tolerances apply to some infrastructure service requirements. It is generally applicable to a line section. It requires calculation of the General Kinematic Structure Gauge of each allowable rolling stock outline on a line. It incorporates track tolerances and rolling stock displacements and allowances.

The rolling stock displacements assume maximum vehicle speed on typical worst-case track condition.

Where reduced tolerances are applied, approval of the Civil Maintenance Engineer is required, and special management systems shall be implemented. New designs in platforms must be registered according to Section 7.3.2.

Calculation of the General Kinematic Structure Gauge is detailed in Section 7.2.

3. Transit Space Waivers

Applicable only in special/restricted circumstances. Each waiver is applicable to a specific location only and requires the approval of the Principal Track and Civil Engineer. It requires calculation of the Kinematic Structure Gauge of the ACTUAL rolling stock operating on a line to determine the worst-case Kinematic Structure Gauge at a particular location.

It incorporates site-specific track tolerances and rolling stock displacements and may require conditions to be placed on the location or rolling stock such as a reduction in train speeds or an increase in inspection or maintenance.

On projects involving design all transit space waivers shall be completed by the track designer with CRN approved engineering authority for review by Principal Track and Civil Engineer in accordance with Section 7.4.

6 Minimum infrastructure service requirements

The following minimum Infrastructure Service Requirements for the positioning of permanent trackside and overhead structures shall be applied in the absence of specific limits imposed by the Civil Maintenance Engineer.

All dimensions are given relative to the design track centre line horizontal position and height relative to the low rail.

6.1 Horizontal

6.1.1 Main line

For main line or crossing loops, the minimum horizontal dimension between the face of the structure closest to the track and design track centreline shall be as detailed in Table 1.

Minimum Horizontal Clearance	Structure
2 150mm	- Structures and structure footings to one metre below design rail level to allow for operation of ballast cleaners. No allowance is required for curve effects. (BELOW RAIL LEVEL ONLY.)
2 400mm	- Signals and associated equipment to enable visibility of signals
3 000mm	- Signal bridge masts adjacent to a track - Temporary construction works adjacent to a track.
3 500mm	- Piers, columns, deflection walls between tracks.
4 300mm	- Bridge substructures and deflection walls (except between tracks) - cuttings without road access - station buildings - columns, footbridges - Signal bridge masts on platforms.

Minimum Horizontal Clearance	Structure
	- Other structures located adjacent to tracks and where road access is not required.
5 500mm	- Other Structures and cuttings located adjacent to tracks and where road access is required between the structure and the track.
6 200mm	- Bridges or air-space developments where a signal mast is required within the structure limits.

Table 1 – Mainline horizontal service requirements

Note 1 The type of vehicles and the intended use of the access road needs to be considered in establishing clearances. If roads are used for maintenance access, sufficient clearance is required so that a person can exit the vehicle normally without infringing the "Danger Zone".

Note 2 An allowance for track curvature and superelevation has been included in the clearances listed in Table 1.

6.1.2 Sidings

For structures adjacent to sidings, the minimum horizontal dimension between the face of the structure closest to the track and design track centreline shall be as detailed in Table 2.

Dimension	Structure
2 500mm	- Non-continuous structures, e.g. isolated columns, doorways and gateways.
3 000mm	- Continuous structures, e.g. walls, material stacks and unbroken fencing.
3 700mm	- Where vehicle doors may open opposite a structure.

Table 2 – Siding horizontal service requirements

Note: Where structures are located in, or within 22 metres of, curves or turnouts, the clearances nominated in Table 2 shall be increased to allow for track curvature effects by including a centre-throw and end-throw component as detailed in Section 7.1.3.

6.2 Vertical

For all track, the minimum vertical dimension between the underside face of the structure and the design height of the low rail shall be as detailed in Table 3.

Dimension	Structure
5 000mm	- Narrow Non-Electric, Narrow Square, Narrow Container, Narrow Hopper

Table 3 – Vertical service requirements

6.3 Track centres

To provide for service requirements, track centres may be increased as shown in Table 4.

Dimension	Application
6 100mm	- for straight tracks. Main line to Main line
6 200mm	- for curved tracks of radius \geq 1000 metres and greater. Main line to Crossing Loop Main line to Refuge Loop
6 400mm	- for curved tracks of radius $<$ 1000 metres Main line to Siding Crossing loop to Siding

Dimension	Application
	Siding to Siding

Table 4 – Track Centre service requirements

The 6.1, 6.2 and 6.4 metres are based on a space of 600mm for a person standing between 2 tracks with a 700mm clearance to each of the kinematic envelopes. This distance may be reduced by 500mm if a handrail or other restraint is provided to hold on to.

7 Structure gauges

7.1 Normal Structure Gauge 1994

Normal Structure Gauge, 1994 is detailed in Figure 1.

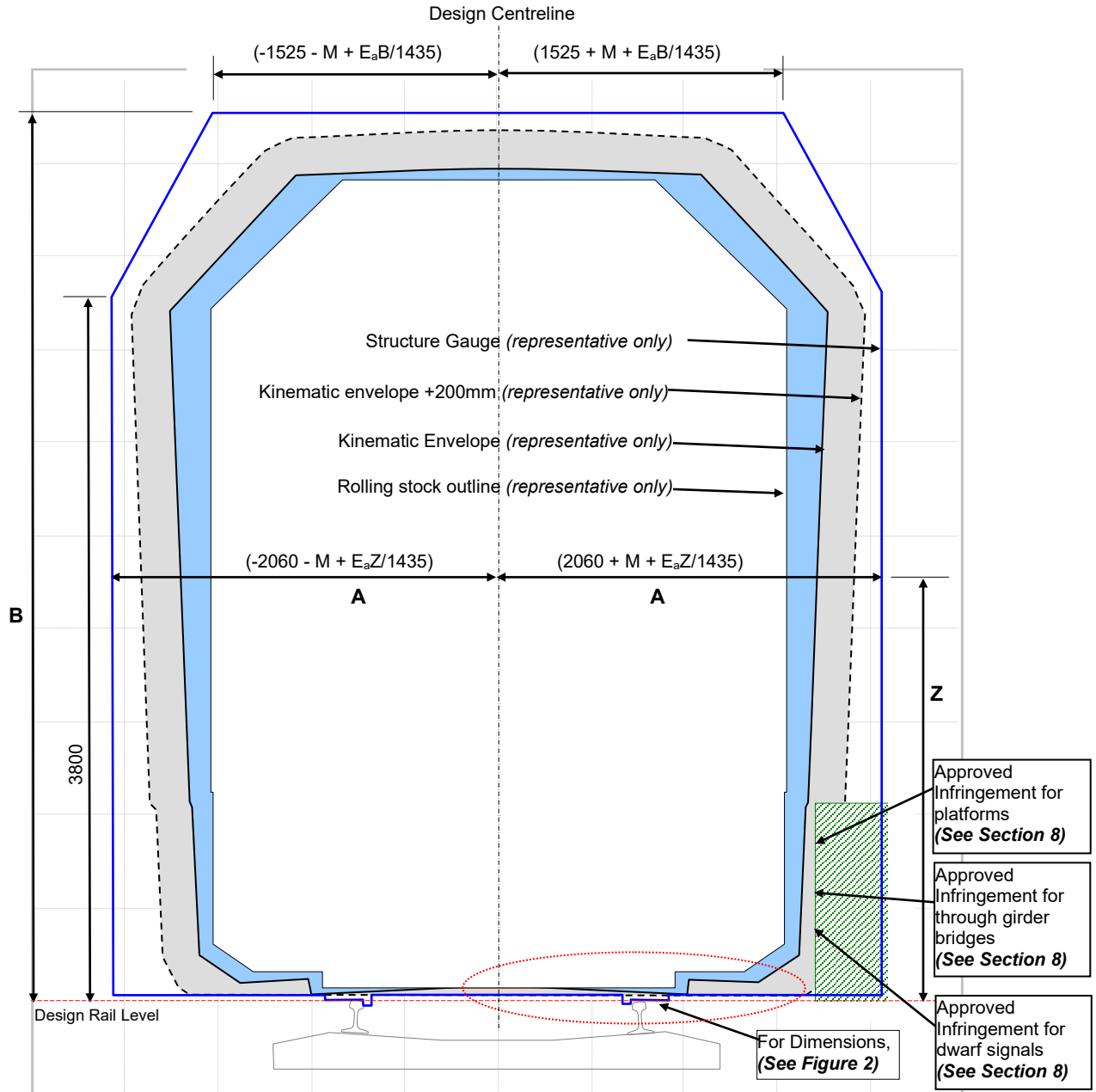

Where:

" E_a " is the Applied Superelevation (right rail in diagram is the low rail).

" B " is the vertical clearance required.

" Z " is the vertical height above the design low rail level.

" M " is the Centre Throw and End Throw component in curves.

For dimensions " B " & " M ", see text.

Figure 1 - Normal Structure Gauge 1994

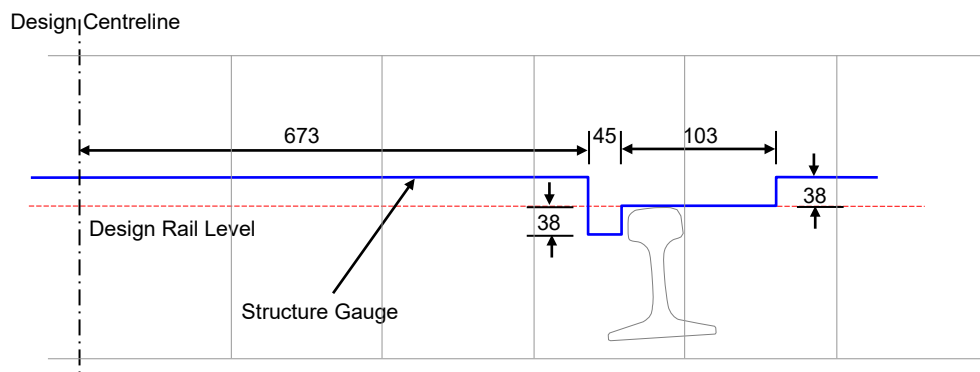

Figure 2 – Structure Gauge Detail at Rail Level

7.1.1 Horizontal clearance

The minimum horizontal dimension from design track centreline to a structure shall be as follows.

Up to a height above design rail height of 3800mm, the minimum horizontal dimension shall be as detailed in Table 5.

Dimension 'A'	Location
$2060 + M + \frac{E_a Z}{1435}$	on the inside of curves
$2060 + M - \frac{E_a Z}{1435}$	on the outside of curves

Table 5 – Horizontal clearance dimension 'A'

Where Z = the height above design rail height

M = a centre-throw and end-throw component as detailed in Section 7.1.3.

The minimum value of Dimension 'A' (2060mm) provides safe clearance for the passage of approved rolling stock and loading Outlines on straight track. Allowance for curve effects must be included as shown in Table 5.

Above 3800mm, the required clearance reduces, as shown in Figure 1, to a minimum horizontal dimension at a height of B, where B is the minimum vertical clearance as detailed in Section 7.1.2. This minimum horizontal dimension shall be as detailed in Table 6.

Dimension	Location	Application
$1525 + M + \frac{E_a B}{1435}$	on the inside of curves	For tracks authorised for the operation of all rolling stock outlines
$1525 + M - \frac{E_a B}{1435}$	on the outside of curves	

Table 6 – Horizontal clearance dimension 'A' at height 'B'

Where M = a centre-throw and end-throw component as detailed in Section 7.1.3

7.1.2 Vertical clearance

Dimension 'B' is the vertical distance from the underside of a structure to the design height of the low rail.

For the following rolling stock outlines, the minimum design value of Dimension 'B' shall be as detailed in Table 7.

Dimension	Rolling Stock Base Outline
4670 + 1.2E _a	Narrow Non-Electric Narrow Square Narrow Container Narrow Hopper

Table 7 – Vertical clearance dimension ‘B’

7.1.3 Curve effects –“M” value (centre and end-throw)

For application of Normal Structure Gauge, 1994, the Centre Throw and End Throw values are assumed to be equal, and are calculated according to the simplified formula in Where $R = \text{Track radius in mm}$

Table 8 applies to both concave and convex curves.

Rolling Stock Base Outline	‘M’
Narrow Based	$M = \frac{32600000}{R}$

Where R = Track radius in mm

Table 8 – ‘M’ Value

7.1.4 Track centres

Minimum design track centres for new works shall be as detailed in Table 9.

Location	Track Centre Dimensions
Main line to Main line	4000 for straight tracks and for curves $\geq 1000\text{m}$ radius
Main line to Crossing □ Loop	For curves $< 1000\text{m}$ radius, track centres shall be.
Main line to Refuge Loop	If $(E_{a_o} - E_{a_i})$ is positive, $3916 + 2M + 2.5(E_{a_{\text{outside}}} - E_{a_{\text{inside}}})$
Siding to Siding (non-examination)	If $(E_{a_o} - E_{a_i})$ is negative, $3916 + 2M$
Main line to Siding	5200 for straight and curved tracks.
Crossing loop to Siding	
Examination Siding	

Table 9 – Track Centres

At locations within yard limits where track centres are less than 4000 mm, either between CRN tracks or between a CRN track and an adjacent track, "Narrow Track Centres" signs shall be exhibited.

The purpose of the sign is to warn train operations personnel of the existence of track centres narrower than 4000 mm. The required response to the signs by operators is specified in CRN Network Rules.

The sign specification and placement requirements are detailed in Section 13.

7.2 General Kinematic Structure Gauge

The General Kinematic Structure Gauge is developed from rolling stock outlines and incorporates track tolerances, rolling stock displacements and tolerances plus a safety clearance margin. It does not include infrastructure service requirements.

Each rolling-stock outline results in a different General Kinematic Structure Gauge that also changes with curve radius and superelevation.

Determination of the transit space requirements for a specific location or a line section will require calculation of the General Kinematic Structure Gauge of all allowable rolling-stock outlines for each change in radius or superelevation. The worst-case outline shall be applied for each case.

The rolling stock displacements assume maximum vehicle speed on typical worst-case track condition. Rolling stock displacements for roll and for bounce are dependent upon vehicle/track interaction and may be reduced by limiting vehicle speed.

Select the rolling stock outlines that are approved for operation on the section of track that is being evaluated (see Section 9).

Track tolerances include allowances for lateral, vertical and rotational movement. The default track tolerances are based on ballasted timber (or steel) -sleepered track in which alignment and top may vary from design over time. Where track is constructed from concrete sleepers or is fixed on a slab or transom topped bridge, reduced movement is expected and, therefore, reduced track tolerances may be applied. The default and reduced tolerances are detailed in Section 10.

Apply the specific rolling stock tolerances detailed in Section 9.2 and the specific track tolerances detailed in Section 10 to the rolling stock outlines using the method detailed in Section 11.

7.3 Platform Kinematic Structure Gauge

7.3.1 General

To apply the Platform Kinematic Structure Gauge, select the rolling stock outlines that are approved for operation on the section of track that is being evaluated (see Section 9).

Apply the lateral and vertical clearances specified in Section 12, using the method also detailed in Section 12.

Register the application of the Platform Kinematic Structure Gauge in accordance with the requirements of Section 7.3.2.

7.3.2 Platform register

The details described in Table 10 must be provided to the Principal Track and Civil Engineer for any new platform design, and when any track redesign is carried out near a platform.

Data		Description	Required
Asset No	Track		Mandatory.
	Platform		Mandatory.
Kilometrage		Kilometrage of Station	Mandatory
Station Name			Mandatory
Rolling stock Outlines		The name of each rolling stock outline considered, from the list of authorised rolling stock outlined in Section 9.	Mandatory
Standard followed		Reference to the name and version number of the standard used. i.e. this standard document.	Mandatory

Table 10 – Platform register data requirements

7.4 Transit space waivers

7.4.1 General

Any location or track section failing to comply with the General Kinematic Structure Gauge must have a waiver approved by the Principal Track and Civil Engineer.

The kinematic structure gauge requirements of the waiver shall be developed from the rolling stock and incorporate site-specific track and rolling stock tolerances and a reduced safety clearance margin. It does not include infrastructure service requirements.

The approval by the Principal Track and Civil Engineer may impose special conditions on the location, which may include any or all of the following:

- Tighter maintenance limits
- Increased inspection intervals
- Limited duration
- Restricted speed.

Register the application of the waiver in accordance with the requirements of Section 7.4.2.

A record of the approval and resulting conditions (if any), shall be maintained by the Civil Maintenance Engineer.

7.4.2 Transit space waiver register

Application for a Transit Space Waiver must be made to the Principal Track and Civil Engineer and must provide the details described in Table 11.

Data	Description	Required
Asset	Track Asset as recorded in CRN database, on double lines record both track assets affected.	Mandatory
Kilometre Start	Kilometrage of the start location of the track section, or the kilometrage of the discrete location.	Mandatory
Kilometre End	Kilometrage of the end location of the track section.	Mandatory for track sections.
MGA Coordinates of Start	Easting and Northing coordinates of the start location of the track section or the coordinates of the discrete location.	Where available.
MGA Coordinates of End	Easting and Northing coordinates of the end location of the track section.	Where available.
Structure geometry	Horizontal and vertical dimensions of structure from design track centreline.	Where appropriate.
Track Geometry	Horizontal geometry (i.e. radius, superelevation, location of frame points), track centres, vertical geometry, relative track levels.	Where appropriate.
Track Structure	Sleeper type, rail size.	Where appropriate.
Operations Description	Rolling stock Outlines, track speed.	Where appropriate.
Duration for which conditions will apply	Specify the time duration that the conditions will apply to the location or track section.	Mandatory.
Authorised Structure Gauge	The Structure Gauge which is being infringed.	Mandatory.
Infringement	Magnitude of infringement to Authorised Structure Gauge in mm.	Mandatory.

Table 11 - Register of application of Conditional Kinematic Structure Gauge

8 Physical interface requirements

Items of infrastructure that are required to physically interface with rolling stock are permitted to be within the structure gauge. These items can only be approved by the Principal Track and Civil Engineer.

Items currently approved include:

- Rail lubricator actuators
- Automatic wagon door openers in the active position
- Overhead wagon loading structures in the lowered position
- Buffer stops
- Dwarf signals

Dwarf signals are permitted to a maximum height of 1065mm above design rail level. Design Lateral clearance from Track Centre to the edge of the signal shall be Kinematic Envelope + 45mm. Where dwarf signals are placed between tracks, the lateral clearance requirements apply to both tracks.

- Through girder underbridges

Through girders on transom top underbridges are permitted to a maximum height of 1065mm above design rail level. Design Lateral clearance from Track Centre to the edge of the girder shall be Kinematic Envelope + 45mm.

- Speed signs (permanent and temporary)
- Ancillary equipment attached to tunnel walls

9 Authorised rolling stock outlines

CRN Engineering standard CRN RS 008 “General Interface Requirements for Rolling Stock” provides rolling stock outlines that are authorised for operation on the CRN and the outlines on which they are based. These outlines are listed in Table 12. No other rolling stock outlines are permitted.

Rolling stock Outline Name	Base Outline	Reference Drawing
Narrow Non-Electric	Narrow	Figure 12
Narrow Square	Narrow	Figure 13
Narrow Container	Narrow	Figure 14
Narrow Hopper	Narrow	Figure 15

Table 12 - Authorised Rolling Stock Outlines

Table 17 in Appendix 1 details the rolling stock outlines approved for operation on each track section on the CRN network. This information is also shown in summary form in Figure 8 in Appendix 1.

For tracks that are not included in Appendix 1, such as loops, sidings, and yards, the rolling stock outlines authorised on neighbouring tracks shall apply.

Alterations to the outlines and track sections detailed in Appendix 1 can only be authorised by the Principal Track and Civil Engineer in consultation with the Principal Rolling Stock Engineer.

Rolling stock Cross-Sections, bogie centres and body overhangs for each rolling stock outline in Table 5 are detailed in Appendix 2. These dimensions shall only to be used in conjunction with the kinematic tolerances detailed in Section 9.2.

9.1 Dynamic rolling stock allowances

This section details rolling stock dimensions and dynamic displacements that define the swept path of rolling stock outlines for the calculation of Kinematic Structure Gauges.

WARNING:

DO NOT use this information for rolling stock specification or design.

Note 1: Some rolling stock has differing dimensions and/or displacements from the standardised rolling stock outlines but provides an equivalent swept path to the Authorised rolling stock outline, and need not be considered in this standard.

Note 2: Some rolling stock has specially approved items that protrude beyond the standardised rolling stock outline. These are covered by rolling stock Standards, are the responsibility of the rolling stock operators, and need not be considered in this standard.

9.2 General kinematic displacements

The rolling stock displacements in Table 13 shall be used when calculating the General Kinematic Structure Gauge for all authorised rolling stock outlines.

Direction	Relative to	Description	Displacements
Lateral	Relative to the plane of the Superelevation (with any superelevation variation applied)	Body to Wheelset	± 60mm total
		Wheel Wear	
		Wheel/Rail free-play	
		Extra Clearance	± 200mm ^(Note 1)
Vertical	Relative to the displaced vehicle centreline	Bounce Upwards	+ 50mm
		Bounce Downwards	- 0mm
		Extra Clearance Upwards	+ 100mm
		Extra Clearance Downwards	- 0mm
Rotational	Roll about the displaced roll centre of the rolling stock Outline	<i>Note: the roll centre moves laterally and vertically with the rolling stock outline</i>	± 2°

Table 13 - Rolling stock tolerances

Note 1: Determination of track centres in existing track designs has not included consideration of the impact of trains utilising the turnout road on an adjacent track. (the clearance conflict is illustrated in Figure 3 below).

Accordingly, for existing tracks when considering the clearance impact of rolling stock using the turnout route of a turnout on the adjoining track centres the extra clearance may be reduced to 50mm.

The following conditions apply to the application of the reduced limit.

1. The reduced clearance limit has the status of a maximum/ minimum limit where the normal limit is to remain as 200mm extra lateral clearance. Designers shall provide justification for not using the normal limits (as with other design parameters).
2. It is only applicable for the assessment of existing turnouts or for turnout renewals where the constraint is derived from current track-design track centres.

3. All other tolerances shall to be applied.
4. All applicable rolling stock envelopes shall be considered.

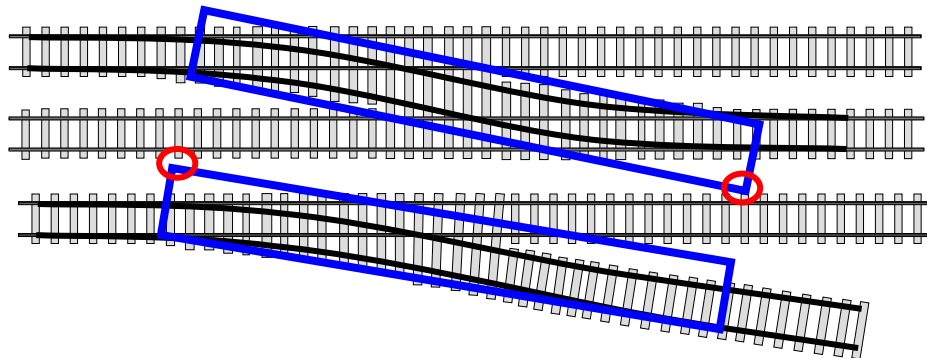

Figure 3 –Clearance conflicts for trains using turnout road on adjacent tracks highlighted by red circle

10 Track tolerances

10.1 Open track

This section details the track tolerances to be included when calculating the various Kinematic Structure Gauges to allow for variation of track from design.

Note: Track tolerances used in the calculation of Kinematic Structure Gauges may differ from those imposed for design or maintenance of track.

The track tolerances detailed in Table 14 shall be used for all authorised rolling stock outlines, when calculating the General Kinematic Structure Gauge.

Direction	Description	Relative to		Tolerance
Ballasted track (timber or steel sleepers)				
Lateral	Alignment	Rail Wear		15mm
		Horizontal difference from design	tangent and curves $\geq 2000\text{m}$ radius	$\pm 25\text{mm}$
curves $< 2000\text{m}$ radius	$\pm 35\text{mm}$			
Vertical	Level	Difference from design		$\pm 150\text{mm}$
Rotational	Superelevation	Difference from design		$\pm 10\text{mm}$
Ballasted track (Concrete sleepers)				
Lateral	Alignment	Rail Wear		15mm
		Horizontal difference from design	tangent and curves $\geq 2000\text{m}$ radius	$\pm 15\text{mm}$
curves $< 2000\text{m}$ radius	$\pm 25\text{mm}$			
Vertical	Level	Difference from design		$\pm 150\text{mm}$
Rotational	Superelevation	Difference from design		$\pm 10\text{mm}$
Slab track and Transom Top Bridges				
Lateral	Alignment	Rail Wear		15mm
		Horizontal difference from design	tangent and curves $\geq 2000\text{m}$ radius	$\pm 10\text{mm}$
curves $< 2000\text{m}$ radius	$\pm 20\text{mm}$			

Direction	Description	Relative to	Tolerance
Vertical	Level	Difference from design	± 50mm
Rotational	Superelevation	Difference from design	± 10mm

Table 14 - Track tolerances

10.2 Platforms

See Section 12.

11 Calculation of kinematic structure gauges

11.1 General

This Section details the method to be used to apply track tolerances and rolling stock displacements to a particular rolling stock outline, at a particular track location, in order to determine the General Kinematic Structure Gauge.

The Kinematic Envelope is the outline generated by a moving vehicle, taking into account vehicle and track effects as listed in Sections 8 and 10.

A different Kinematic Envelope will apply for each rolling stock outline.

At any particular location, the kinematic structure gauge is the maximum envelope created by superimposing the kinematic envelopes of all authorised rolling stock outlines for that track section.

All kinematic diagrams used in project design shall be shown on the final issued for construction drawings with track tolerances from table 14 and displacements from table 13 used clearly tabled.

11.2 Calculation of kinematic envelope

The authorised track tolerances and rolling stock displacements are applied to the rolling stock Cross-Section relative to the reference plane specified.

- All lateral rolling stock displacements and centre and end throws are applied relative to the coordinate system of the wheelset, which follows the plane of the superelevation (including superelevation tolerances).
- All rotational rolling stock displacements are applied about the roll centre, which is fixed to the coordinate system of the rolling stock outline, which shifts laterally relative to the wheelset.
- All vertical rolling stock displacements are applied relative to the coordinate system of the rolling stock outline, which rolls and shifts laterally relative to the wheelset.
- All lateral alignment track tolerances are applied relative to horizontal.
- Lateral track tolerances caused by any variation in the rail are applied relative to the plane of the superelevation. For the purposes of General Kinematic Structure Gauge, these displacements have been included in the lateral rolling stock displacements.
- All vertical track tolerances are applied relative to horizontal.
- All rotational track tolerances and the design superelevation are applied relative to horizontal.

The order in which these are applied is unimportant, provided that the tolerances and displacements are applied relative to their correct reference body.

11.2.1 Centre and end throw

Centre and end throw of vehicles is calculated as follows:

$$C_t = \frac{B_c^2}{8R}$$

$$E_t = \frac{L^2}{8R + 4W} - C_t$$

where C_t = centre throw of nominated vehicle in mm.

E_t = end throw of nominated vehicle in mm.

B_c = bogie centres of nominated vehicle in mm.

R = radius of curve in mm.

L = length of nominated vehicle in mm (where $L = B_c + 2B_o$).

B_o = body overhang of nominated vehicle in mm.

W = width of nominated vehicle in mm.

Note: Centre and End Throw is not to be applied to the areas on the rolling stock outline designated "Outline Extension for Bogie Components Only", "Physical Interface for Wheels Only", and "Physical interface for Trip Valve Arm Only", as these areas are restricted to the region of the bogie.

11.3 Kinematic track centres

The Kinematic Track Centre is determined by superimposing the Kinematic Envelopes of all authorised rolling stock outlines on each track, noting that the worst case may be the centre throw of one vehicle with the end throw of a different vehicle. Extra Clearances of rolling stock on adjacent tracks are permitted to overlap (i.e. the Extra Lateral Clearance need only be applied to the Kinematic Envelopes calculated on one of the tracks).

12 Calculation of platform kinematic structure gauge

12.1 General

This method summarises and simplifies the Kinematic Structure Gauge for platforms.

Platforms are the only structures authorised to be built to the Platform Kinematic Structure Gauge. Other structures in the vicinity of platforms MUST NOT use the Platform Kinematic Structure Gauge.

12.2 Normal platform dimensions

12.2.1 Platform heights

The height V_s , to a platform coping above Design Rail Level for varying rolling stock outlines on straight track shall be as detailed in Note 1. Some platforms within the CRN were designed with a V_s of 965mm, in this instance for defining the design alignment only (ie no track or platform works) this vertical height may be used in consultation with TfNSW

Table 15.

The height to a platform coping above Design Rail Level (low rail) on curved track shall be:

$$V_c = V_s + 1.7E_a \text{ for a concave platform}$$

$$V_v = V_s - 0.7E_a \text{ for a convex platform}$$

Where E_a = Design superelevation at the point in the track being analysed.

12.2.2 Platform lateral clearances

The horizontal clearance H_s between a straight Standard Access platform coping edge and the design centreline of the adjacent track is shown in Note 1. Some platforms within the CRN were designed with a V_s of 965mm, in this instance for defining the design alignment only (ie no track or platform works) this vertical height may be used in consultation with TfNSW

Table 15 and Figure 4.

Rolling Stock Type	Sleeper Type	H_s (mm)	K	k	V_s (mm)
Narrow Based	All	1575	32600	0.67	1065 ⁽¹⁾

Note 1. Some platforms within the CRN were designed with a V_s of 965mm, in this instance for defining the design alignment only (ie no track or platform works) this vertical height may be used in consultation with TfNSW

Table 15 - Platform clearance dimensions

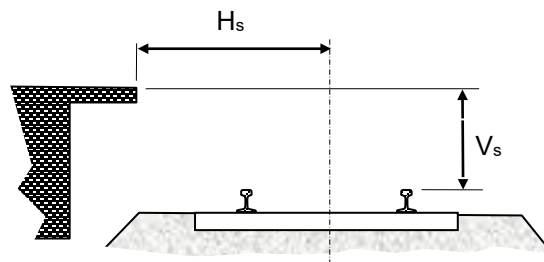

Figure 4 - Platform clearances on tangent track

12.2.2.1 Curved Track

The horizontal clearance to concave and convex platforms is shown in Figure 5 by H_c and H_v respectively as follows:

$$H_c = H_s + \frac{K}{R} - kE_a \text{ for concave platform}$$

$$H_v = H_s + \frac{K}{R} + kE_a \text{ for convex platform}$$

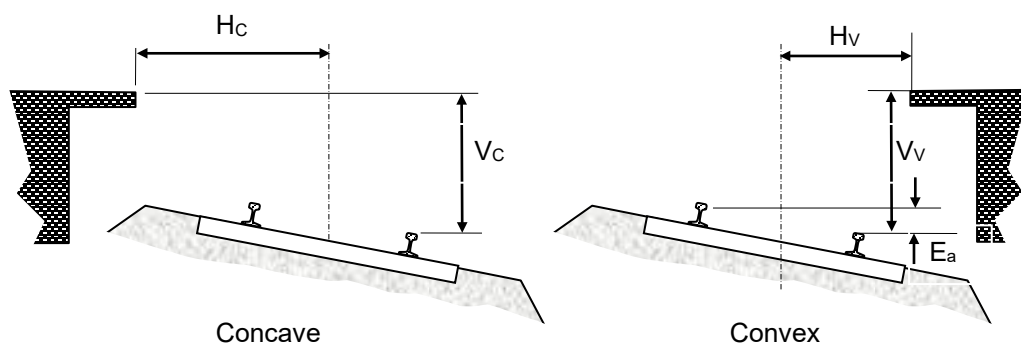

Figure 5 - Platform clearances on curved track

12.2.2.2 Transitioned Track

Determination of the clearances to platforms adjacent to transition curves, or within a vehicle length of a transition curve is complex, being a function of the radii and superelevation of the track at both bogies of the relevant vehicle. Three-dimensional modelling is preferred for all new designs. Methods of calculation shall be approved by the Principal Track and Civil Engineer. Note that 3D modelling is not dynamic modelling.

The following simplified formulae provide automatic smoothing of geometries and may be used for simple geometric situations as well as where there are gradual changes in geometry. They should not be used if there are multiple geometric segments within "L".

The radius used is the effective radius at the point in the track being analysed, and the superelevation used is the effective superelevation at the point in the track being analysed.

$$H_C = H_S + \frac{K}{R_e} - kE_{a_e} \quad \text{for concave platform.}$$

$$H_V = H_S + \frac{K}{R_e} + kE_{a_e} \quad \text{for convex platform.}$$

The effective superelevation (E_{a_e}) for a **concave** platform is the average superelevation of two points on the track, which are a distance of $\frac{L+B_c}{2}$ and $\frac{L-B_c}{2}$, in the direction of increasing superelevation, from the point in the track being analysed.

The effective superelevation (E_{a_e}) for a **convex** platform is the average superelevation of two points on the track, which are a distance of $\frac{B_c}{2}$, in each direction, from the point in the track being analysed.

The effective radius (R_e) for a **concave** platform is the average radius of two points on the track, which are a distance of $\frac{L+B_c}{2}$ and $\frac{L-B_c}{2}$, in the direction of tightening radius, from the point in the track being analysed.

The effective radius (R_e) for a **convex** platform is the average radius of two points on the track, which are a distance of $\frac{B_c}{2}$, in each direction, from the point in the track being analysed.

The average radius of two points can be determined using the following formula:

$$R_e = \frac{2}{\left(\frac{1}{R_1} + \frac{1}{R_2}\right)}$$

Where R_1 and R_2 are the radii at each of the two points.

E_a and R at any point in a transition can be determined from formulae provided in CRN Engineering standard CRN CS 210 "Track Geometry and Stability".

12.2.2.3 Non-transitioned curves

The clearances to platforms adjacent to non-transitioned curves, or within a vehicle length of a non-transitioned curve, are considered complex situations and shall only be determined by use of approved 3D modelling techniques.

13 Reduced track centre signs

Reduced Track Centre signs shall be manufactured in accordance with the requirements of CRN Engineering specification CRN CP 213 "Trackside Signs".

13.1 Description

The signs contain the words "Danger Narrow Track Clearances" in black text on a white background as shown in Figure 6.



Figure 6 – Narrow Track Clearances Sign

13.2 Size

Where signs are provided at entry points to yards/sidings, they shall to be 600 mm wide x 400mm high.

Where signs are provided at point levers or main frame levers, they shall be 400 mm wide x 300mm high.

13.3 Position of signs

The number and location of signs within a yard shall be determined by a risk assessment. The minimum requirement is 2 signs, one at each end.

Signs shall to be positioned:

- At least 2.2m above rail level (centre of sign).
- Clear of structure gauge.
- To be clearly visible to train operations personnel.
- So as not to be associated with any signals.
- So as not to restrict the operator's normal field of vision or operation of levers.
- So as not to present a tripping hazard, or a head or body collision hazard to personnel.

13.4 Documentation

The positioning of all signs shall be documented on the applicable track layout diagram.

14 Acceptance standards

14.1 Construction tolerances at structures (other than platforms)

Physical construction of structures adjacent to track infrastructure shall not reduce the transit space safety margins. Design of structures shall consider construction tolerances when establishing clearance requirements.

14.2 Construction and maintenance tolerances at platforms

The tolerances detailed in Table 16 apply to the construction or renewal of platforms and the construction, renewal or maintenance of track through platforms. Measurement conventions are shown in Figure 7.

Application	Tolerances (mm)	Comments
Height tolerance		
Construction or renewal of platforms	- 0 to + 25	Relative to design rail level. (See Figure 7)
Construction or renewal of track at platforms	- 0 to + 50	Relative to design rail level. (See Figure 7)
Maintenance of track at platforms	- 0 to + 50	Relative to design rail level. (See Figure 7) (See Note 2)
Lateral clearance tolerance		
Construction or renewal of platforms	- 0 to + 5	Relative to design alignment. (See Figure 7)
Construction of track at platforms	± 6mm	Relative to design track alignment.
Maintenance or renewal of track at platforms	± 15mm	Relative to actual track alignment.
Superelevation tolerance		
Construction or renewal of track at platforms	± 5mm	Relative to design superelevation.
Maintenance of track at platforms	± 6mm	Relative to of design superelevation.

Table 16 - Construction and maintenance tolerances at platforms

Note 1: ± 5mm preferred where practical

- Over time the track level will rise as a result of maintenance resurfacing. When track maintenance is carried out any lifts that will take the rail level above the tolerances should be minimised.

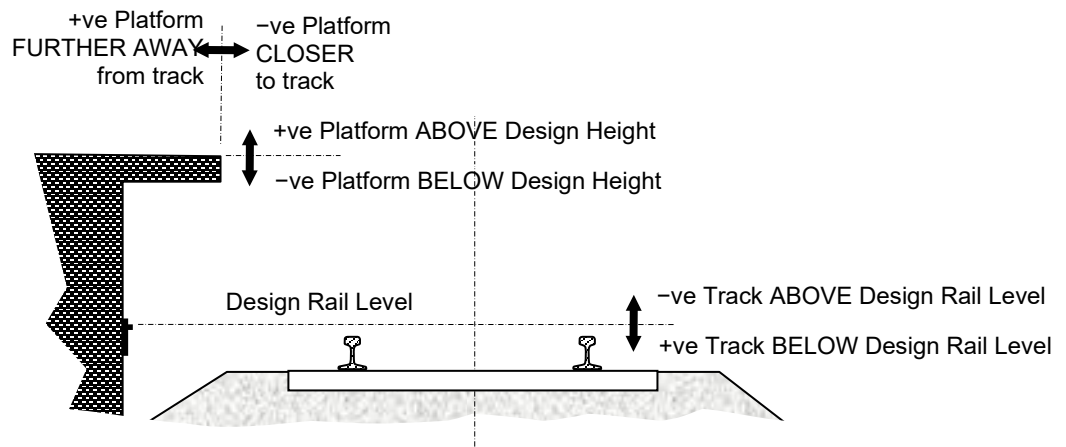

Figure 7 – Measurement Conventions

Appendix 1 Authorised rolling stock outlines

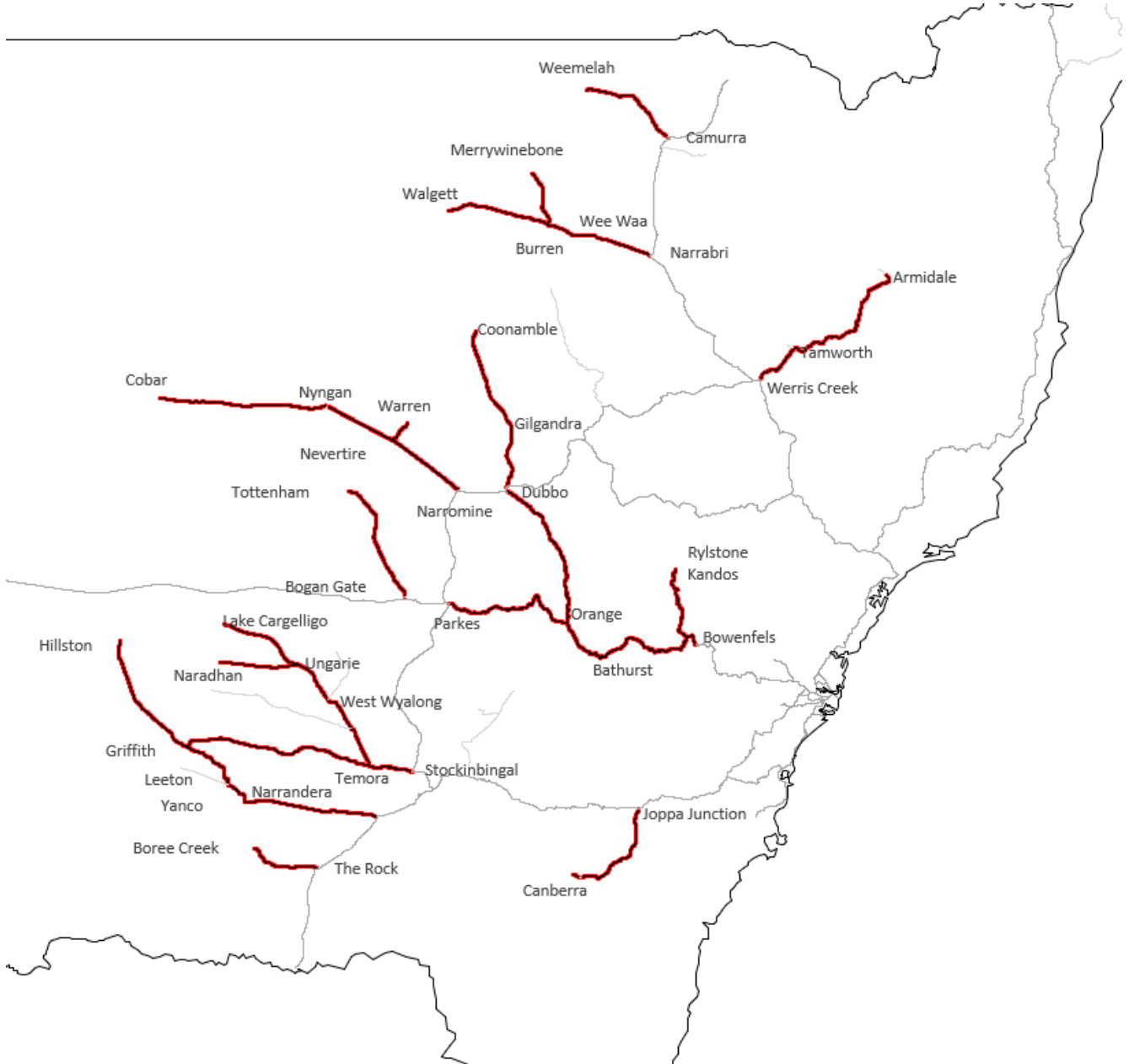

Figure 8 – Narrow Non-electric Rolling Stock Outlines on CRN Operational lines

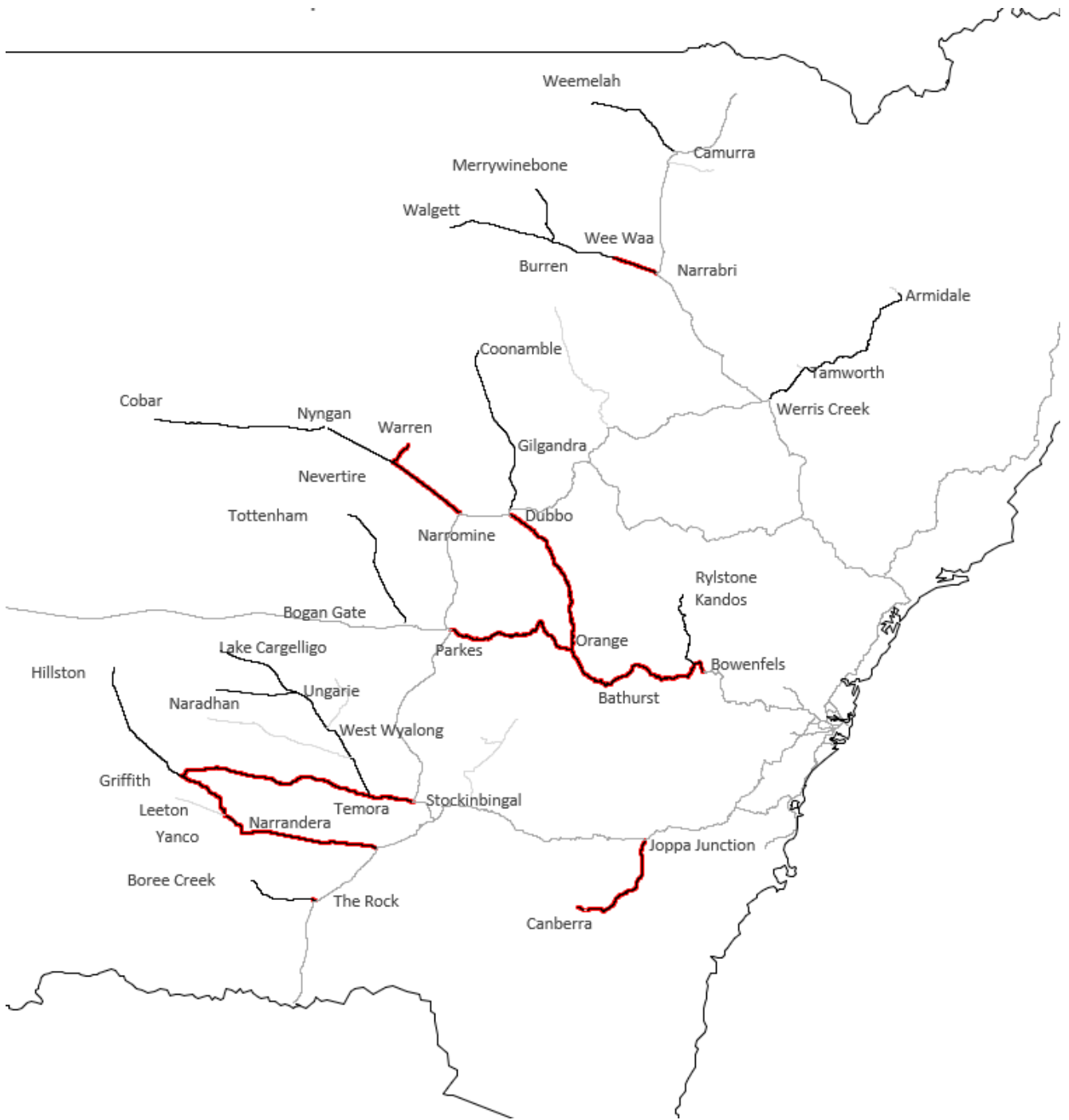

Figure 9 – Narrow Square Rolling Stock Outlines on CRN Operational lines

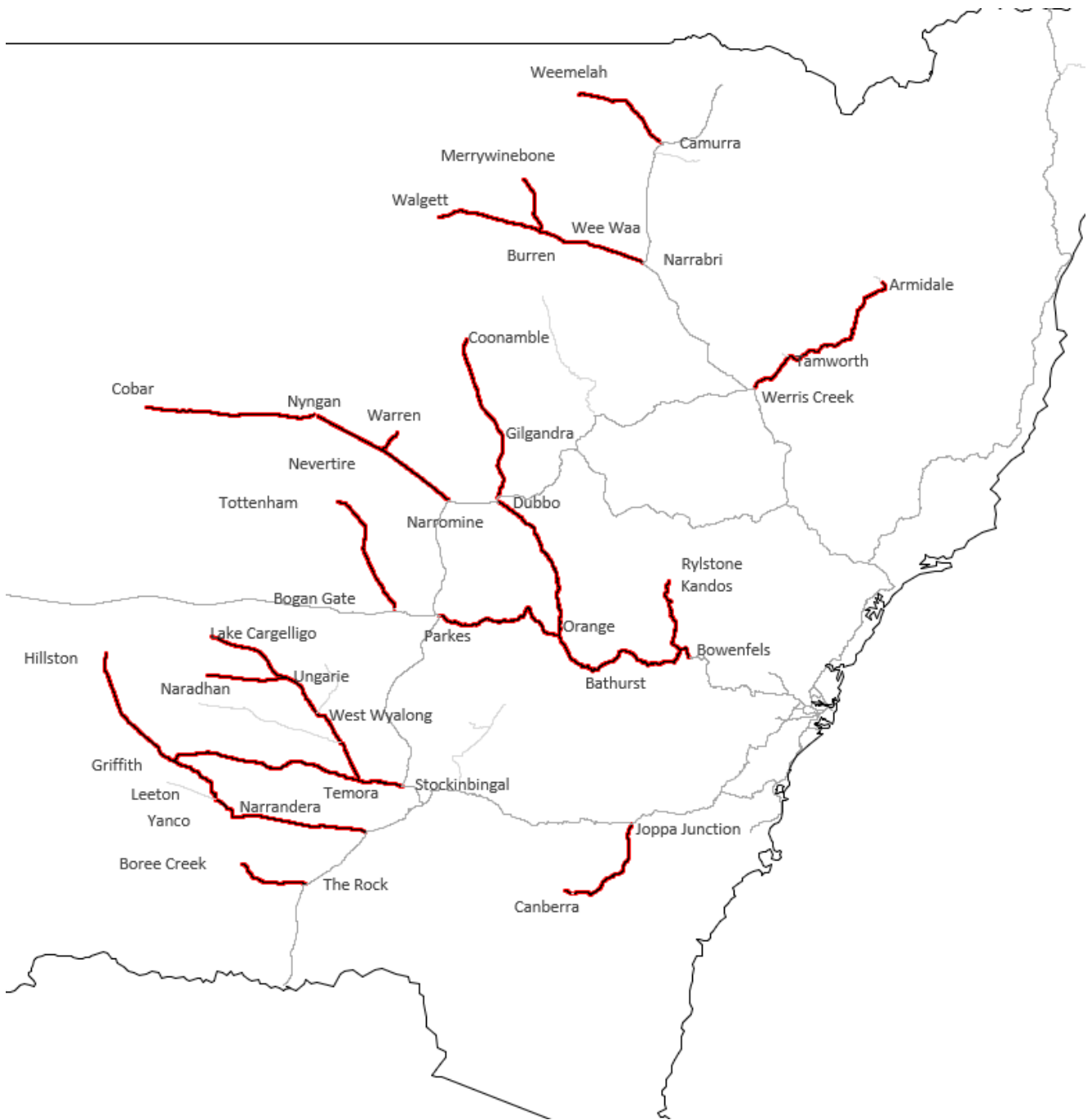

Figure 10 – Narrow Hopper Rolling Stock Outlines on CRN Operational lines

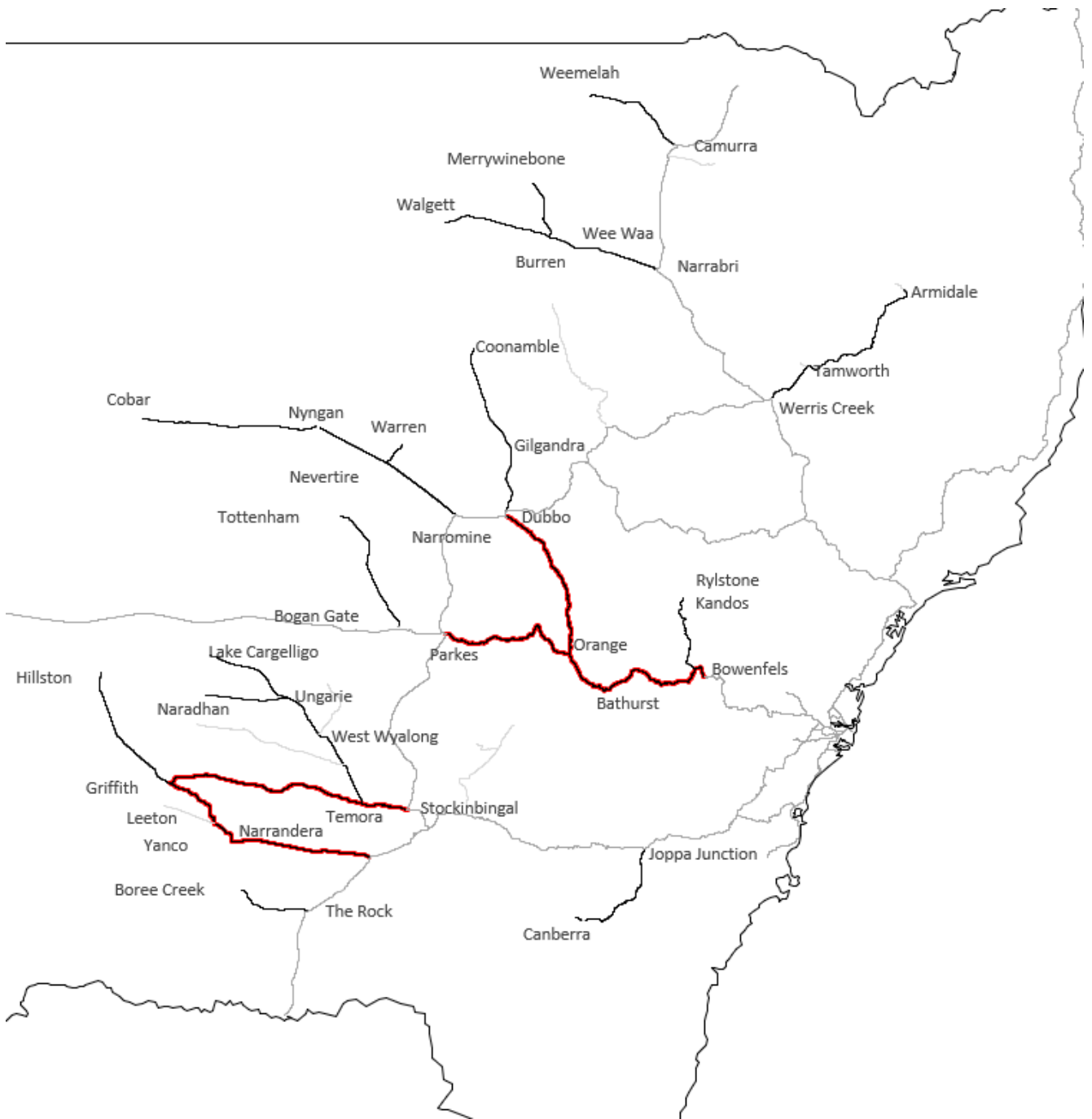

Figure 11 – Narrow Container Rolling Stock Outlines on CRN Operational lines

Table 17 - Authorised rolling stock outlines on track sections

Legend															
Y	The Outline is authorised to operate, and shall be considered when designing or maintaining the Infrastructure.				N	The Outline is not authorised , and does not need to be considered when designing or maintaining the Infrastructure.									
Base Code	Track Name	From			To			Narrow Non-Electric	Narrow Square	Narrow Container	Narrow Hopper	Intersystem	Out of Gauge Load	NZTA Wagon	
		km	Track Location	Location Description	km	Track Location	Location Description								
North															
10003	Main North, Single Line	411.201	Werris Creek	CRN boundary	452.700	West Tamworth	Frame C	Y	N	N	Y	N	N	N	
		452.700	West Tamworth	Frame C	679.300	Armidale	Stop Block	Y	N	N	Y	N	N	N	
10021	Narrabri Junction to Walgett, Single Line	564.799	Narrabri South	CRN boundary	600.200	Wee Waa	Frame B	Y	Y	N	Y	N	N	N	
		600.200	Wee Waa	Frame B	736.480	Walgett	Dead end	Y	N	N	Y	N	N	N	
10018	Werris Creek to Mungindi, Single Line	679.040	Camurra West	CRN boundary	762.836	Weemelah	Stop Block	Y	N	N	Y	N	N	N	
10023	Burren Junction to Merrywinebone, Single line	648.500	Burren Junction	Frame C	701.012	Merrywinebone	Stop Block	Y	N	N	Y	N	N	N	
South															
10065	Joppa Junction to Bombala, Single Line	230.612	Joppa Junction	CRN boundary	321.662	Queanbeyan	2F Points	Y	Y	N	Y	N	N	N	
10067	Queanbeyan to Canberra, Single Line	321.662	Queanbeyan	2F Points	29.614	Canberra	Dead end	Y	Y	N	Y	N	N	N	
10071	Cootamundra to Lake Cargelligo, Single Line	454.906	Stockinbingal	CRN boundary	489.550	Temora	2G Points	Y	Y	Y	Y	N	N	N	
		489.550	Temora	2G Points	669.191	Lake Cargelligo	Dead end	Y	N	N	Y	N	N	N	
10077	Temora to Griffith and Roto, Single Line	489.550	Temora	12 Points to Griffith	640.684	Griffith	Frame G	Y	Y	Y	Y	N	N	N	
		640.684	Griffith	Frame G	748.500	Hillston	Stop Block	Y	N	N	Y	N	N	N	
10074	Junee to Hay, Single Line	486.021	Junee	CRN Boundary	606.872	Yanco	Frame G	Y	Y	Y	Y	N	N	N	
10076	Yanco to Griffith, Single Line	606.070	Yanco	G Points	660.426	Griffith	Frame D	Y	Y	Y	Y	N	N	N	
10042	Ungarie to Naradhan, Single Line	597.803	Ungarie	Frame C	658.272	Naradhan	Dead End	Y	N	N	Y	N	N	N	
10061	The Rock to Oaklands, Single Line	551.075	The Rock	CRN boundary	553.922	The Rock ABA	Shunt limit board	Y	Y	N	Y	N	N	N	
		553.922	The Rock ABA	Shunt limit board	607.763	Boree Creek	Stop Block	Y	N	N	Y	N	N	N	
West															
10177	Main West, Down	155.800	Bowenfels	CRN Boundary	171.420	Wallerawang	54B Points	Y	Y	Y	Y	N	N	N	
10178	Main West, Up	155.800	Bowenfels	CRN Boundary	171.420	Wallerawang	54B Points	Y	Y	Y	Y	N	N	N	
10179	Main West, Single Line	171.420	Wallerawang	54B Points	198.350	Tarana	57 Points	Y	Y	Y	Y	N	N	N	
10180	Main West, Down	198.350	Tarana	57 Points	238.789	Bathurst	45 Points	Y	Y	Y	Y	N	N	N	

Table 17 - Authorised rolling stock outlines on track sections

Legend															
Y	The Outline is authorised to operate, and shall be considered when designing or maintaining the Infrastructure.				N	The Outline is not authorised , and does not need to be considered when designing or maintaining the Infrastructure.									
Base Code	Track Name	From			To			Narrow Non-Electric	Narrow Square	Narrow Container	Narrow Hopper	Intersystem	Out of Gauge Load	NZTA Wagon	
		km	Track Location	Location Description	km	Track Location	Location Description								
10181	Main West, Up	198.350	Tarana	57 Points	238.789	Bathurst	45 Points	Y	Y	Y	Y	N	N	N	
10182	Main West, Single Line	238.789	Bathurst	45 Points	273.210	Newbridge	51 Points	Y	Y	Y	Y	N	N	N	
10183	Main West, Down	273.210	Newbridge	51 Points	287.300	Murrobo	2 Points	Y	Y	Y	Y	N	N	N	
10184	Main West, Up	273.210	Newbridge	51 Points	287.300	Murrobo	2 Points	Y	Y	Y	Y	N	N	N	
10185	Main West, Single Line	287.300	Murrobo	2 Points	308.490	Spring Hill	6A Points	Y	Y	Y	Y	N	N	N	
10186	Main West, Down	308.490	Spring Hill	6A Points	320.760	Orange East Fork Junction	53 Points	Y	Y	Y	Y	N	N	N	
10187	Main West, Up	308.490	Spring Hill	6A Points	320.760	Orange East Fork Junction	53 Points	Y	Y	Y	Y	N	N	N	
10045	Main West, Single Line	320.760	Orange East Fork Junction	53 Points	460.090	Dubbo	CRN Boundary	Y	Y	Y	Y	N	N	N	
		497.809	Narromine West	CRN Boundary	563.950	Nevertire	2C Points	Y	Y	N	Y	N	N	N	
		563.950	Nevertire	2C Points	621.700	Nyngan	Frame 1H	Y	N	N	Y	N	N	N	
10166	Nyngan to Cobar, Single Line	621.700	Nyngan	Frame 1H	754.700	Cobar	CRN Boundary	Y	N	N	Y	N	N	N	
10143	Orange to Broken Hill, Single Line	320.760	Orange East Fork Junction	54 Points	446.950	Parkes	CRN Boundary	Y	Y	Y	Y	N	N	N	
10147	Dubbo to Coonamble, Single Line	466.231	Troy Junction	CRN boundary	616.050	Coonamble	Dead End	Y	N	N	Y	N	N	N	
10164	Bogan Gate to Tottenham, Single Line	486.050	Bogan Gate	CRN boundary	598.454	Tottenham	Dead End	Y	N	N	Y	N	N	N	
10165	Nevertire to Warren, Single Line	563.950	Nevertire	2C Points	573.500	Auscott	Frame 1B	Y	Y	N	Y	N	N	N	
		573.500	Auscott	Frame 1B	582.100	Warren South to Warren	Stop Block	Y	Y	N	Y	N	N	N	
10148	Wallerawang to Gwabegar, Single Line	171.900	Wallerawang	55 Points	249.368	Kandos	Stop Block	Y	N	N	Y	N	N	N	
	Airley Balloon Loop	212.190	Airley Loop Junction	51A Points	NA	Airley Balloon Loop	NA	Y	N	N	Y	N	N	N	
10225	Charbon Balloon Loop	244.600	Charbon Junction	2A Points	248.000	Charbon Balloon Loop	NA	Y	N	N	Y	N	N	N	
10226	Baal Bone Balloon Loop	193.800	Baal Bone Junction	251 Points	193.750	Baal Bone Balloon Loop	261 Points	Y	N	N	Y	N	N	N	
10228	Lidsdale Colliery, Coal Road	169.840	Wallerawang	52A Points to Colliery	171.590	Lidsdale Colliery	Dead End	Y	N	N	Y	N	N	N	

Appendix 2 Rolling stock cross-sections

Bogie Centres: 16155 mm
Body Overhang: 3353 mm

Coordinates

Point	Lateral	Vertical
A	0	75
B	940	75
C	940	152
D	1220	152
E	1450	345
F	1450	1120
G	1485	1120
H	1485	3580
I	1250	3916
J	1065	4040
K	760	4190
L	455	4270
M	0	4270

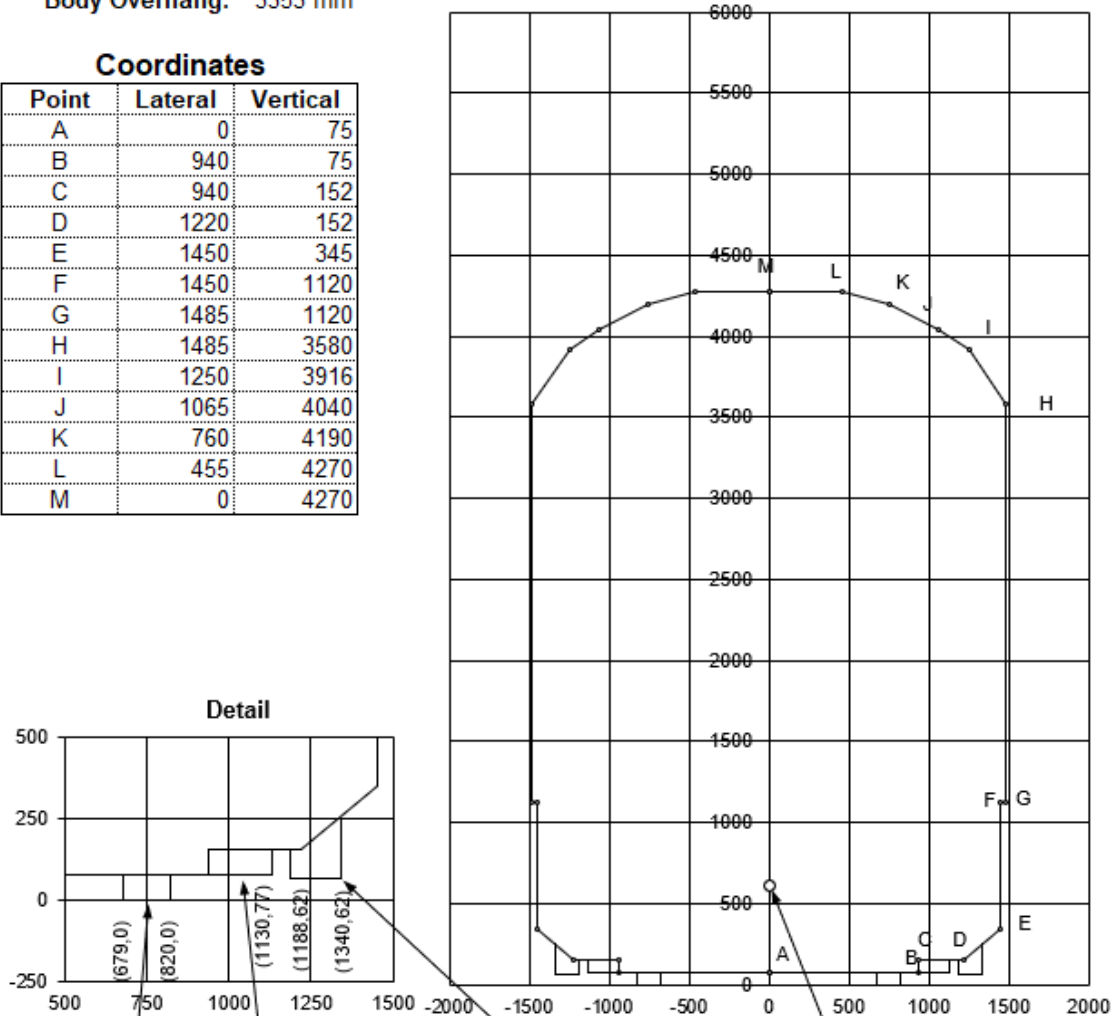

Physical Interface for wheels only. Outline Extension for bogie components only. Physical Interface for trip valve arm only. Roll Centre at 610 mm.

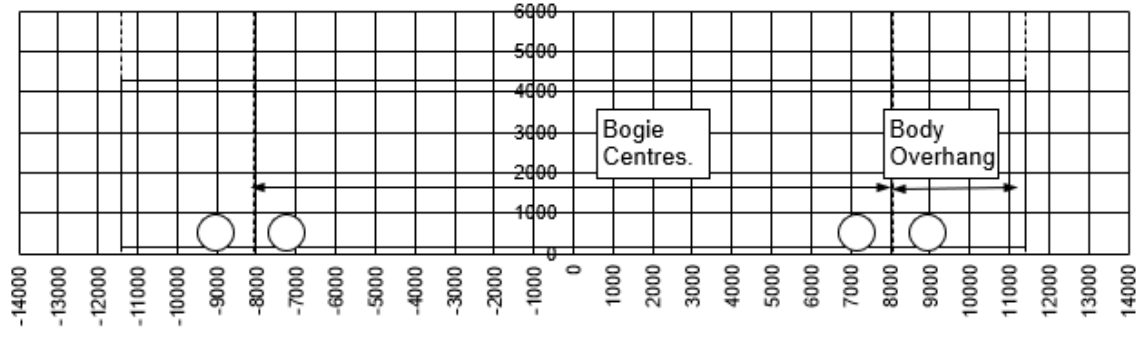

- All cross-section dimensions are symmetrical about the vehicle centreline.
- The origin for all horizontal coordinates is the vehicle centreline.
- The origin for all cross-section vertical coordinates is the rail level.
- All dimensions are in millimetres.

Figure 12 - Narrow Non-Electric rolling stock outline dimensions

Bogie Centres: 16155 mm
Body Overhang: 3353 mm

Coordinates

Point	Lateral	Vertical
A	0	75
B	940	75
C	940	152
D	1450	152
E	1450	1120
F	1485	1120
G	1485	3580
H	1250	3916
I	1065	4040
J	760	4190
K	455	4270
L	0	4270

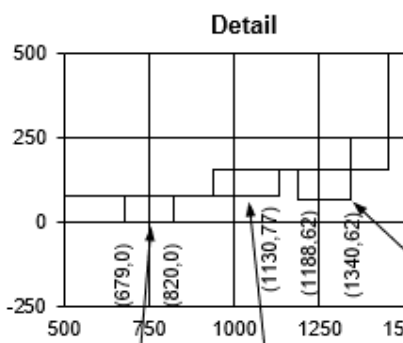
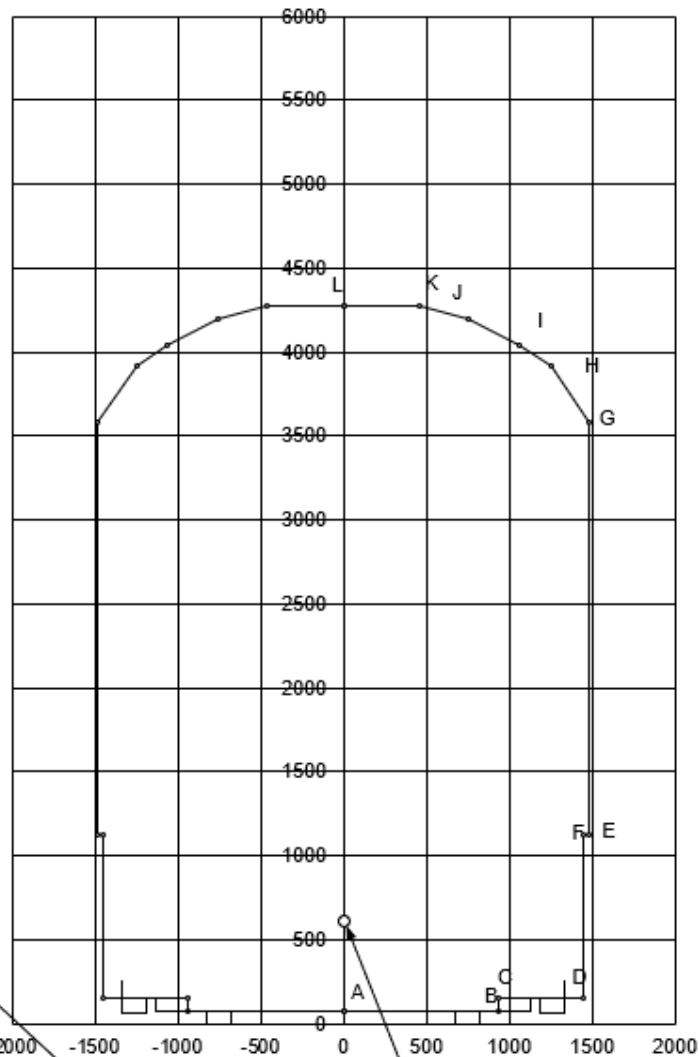

Physical Interface for wheels only.

Outline Extension for bogie components only.

Physical Interface for trip valve arm only.

Roll Centre at 610 mm.

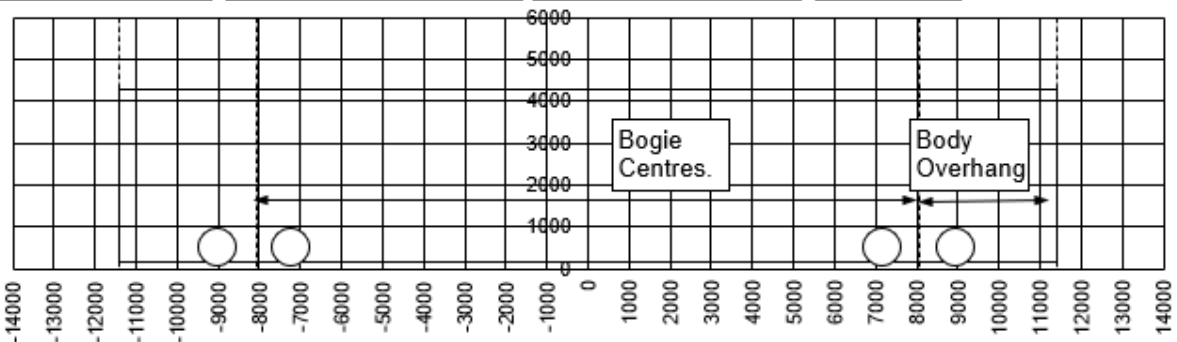

- All cross-section dimensions are symmetrical about the vehicle centreline.
- The origin for all horizontal coordinates is the vehicle centreline.
- The origin for all cross-section vertical coordinates is the rail level.
- All dimensions are in millimetres.

Figure 13 - Narrow Square rolling stock outline dimensions

Bogie Centres: 17300 mm
Body Overhang: 3603 mm

Coordinates

Point	Lateral	Vertical
A	0	75
B	890	75
C	890	152
D	1170	152
E	1400	345
F	1400	1120
G	1435	1120
H	1435	3580
I	1250	4030
J	710	4190
K	405	4270
L	0	4270

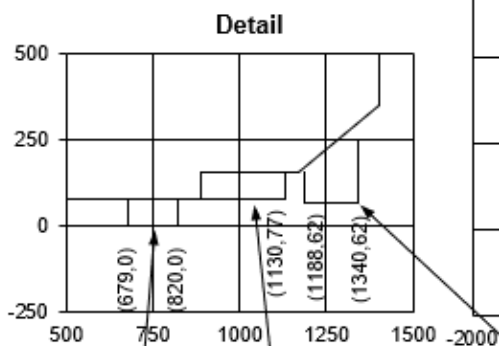
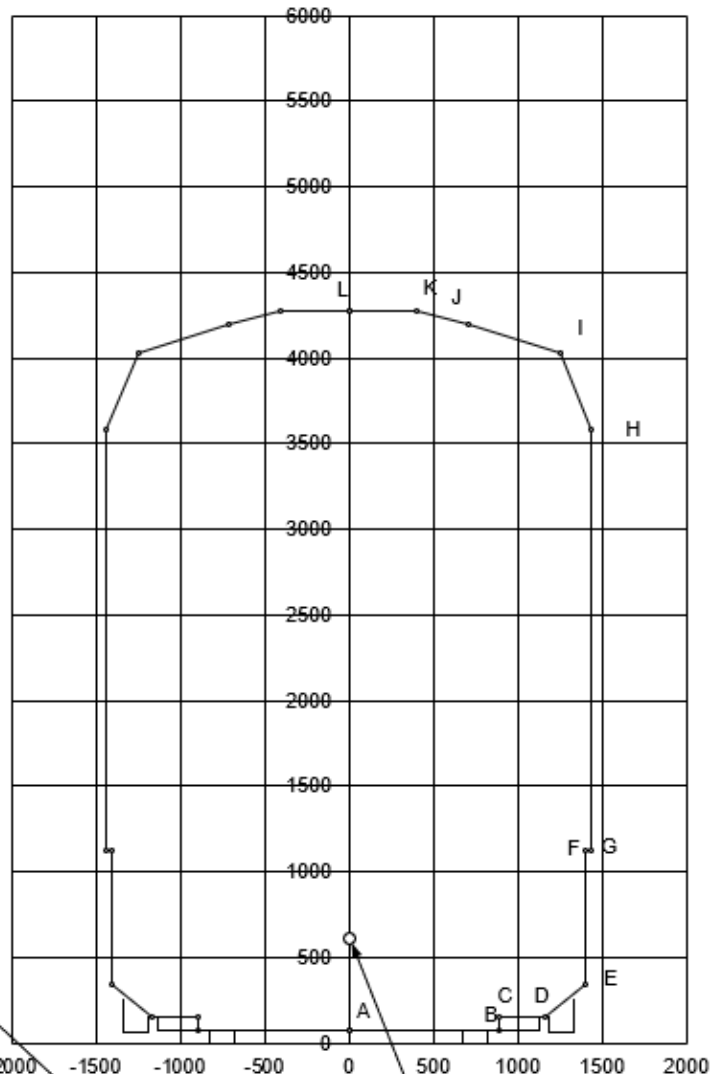

Physical Interface for wheels only.

Outline Extension for bogie components only.

Physical Interface for trip valve arm only.

Roll Centre at 610 mm.

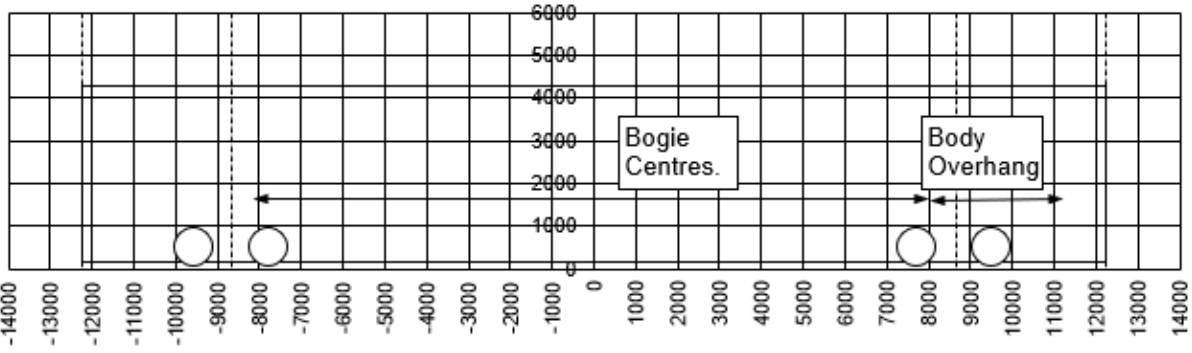

- All cross-section dimensions are symmetrical about the vehicle centreline.
- The origin for all horizontal coordinates is the vehicle centreline.
- The origin for all cross-section vertical coordinates is the rail level.
- All dimensions are in millimetres.

Figure 14 - Narrow Container rolling stock outline dimensions

Bogie Centres: 13000 mm
Body Overhang: 1500 mm

Coordinates

Point	Lateral	Vertical
A	0	75
B	940	75
C	940	152
D	1220	152
E	1450	345
F	1450	1120
G	1485	1120
H	1485	1800
I	1510	2075
J	1525	2350
K	1510	2625
L	1485	2900
M	1485	3580
N	1250	3916
O	1065	4040
P	760	4190
Q	455	4270
R	0	4270

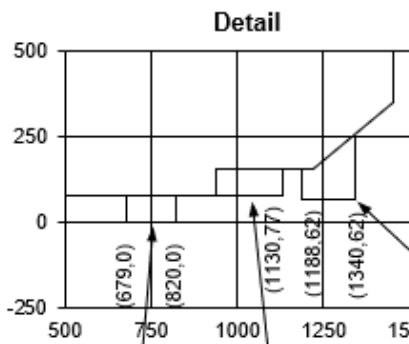
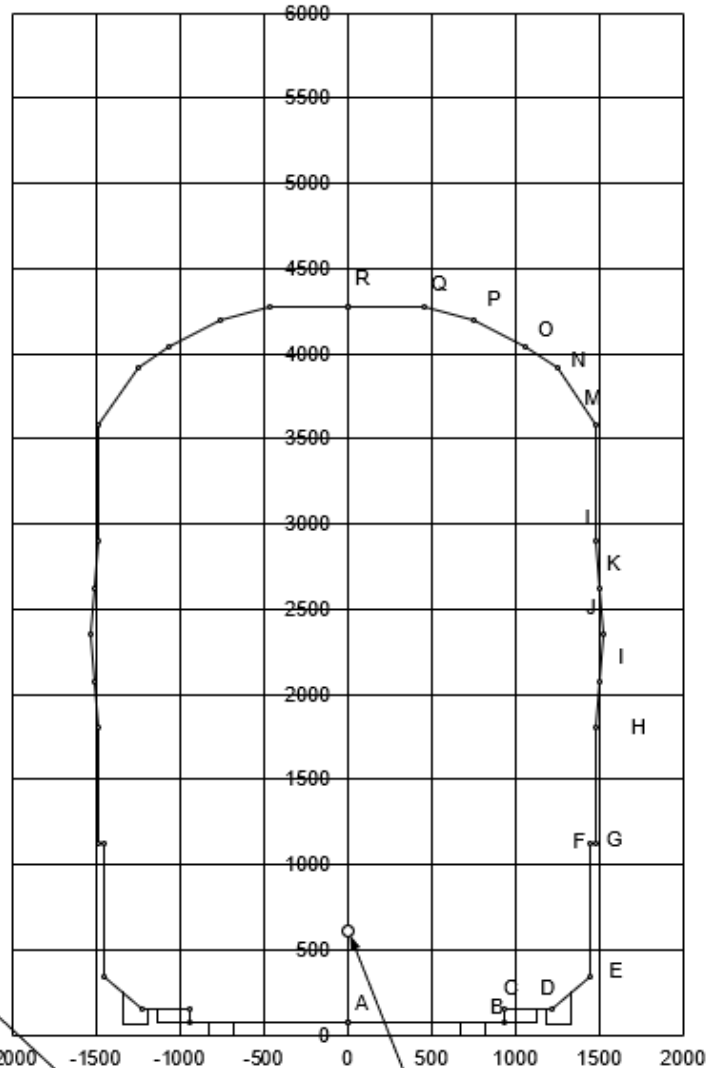

Physical Interface for wheels only.

Outline Extension for bogie components only.

Physical Interface for trip valve arm only.

Roll Centre at 610 mm.

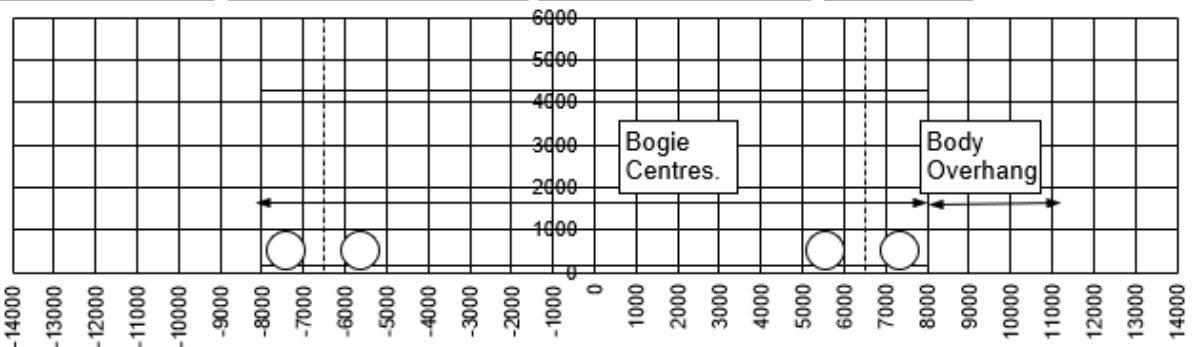

- All cross-section dimensions are symmetrical about the vehicle centreline.
- The origin for all horizontal coordinates is the vehicle centreline.
- The origin for all cross-section vertical coordinates is the rail level.
- All dimensions are in millimetres.

Figure 15 - Narrow Hopper rolling stock outline dimensions

Bogie Centres: 15240 mm
Body Overhang: 1980 mm

Coordinates

Point	Lateral	Vertical
A	0	75
B	940	75
C	940	152
D	1220	152
E	1448	345
F	1448	1219
G	1473	1219
H	1473	1270
I	1867	1270
J	1867	3048
K	1600	3658
L	914	4343
M	0	4343

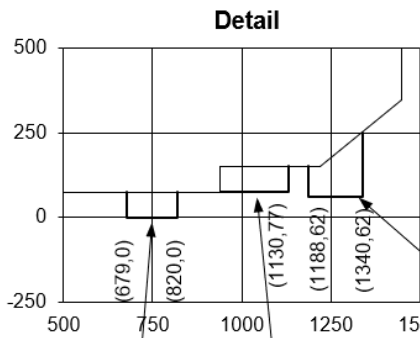
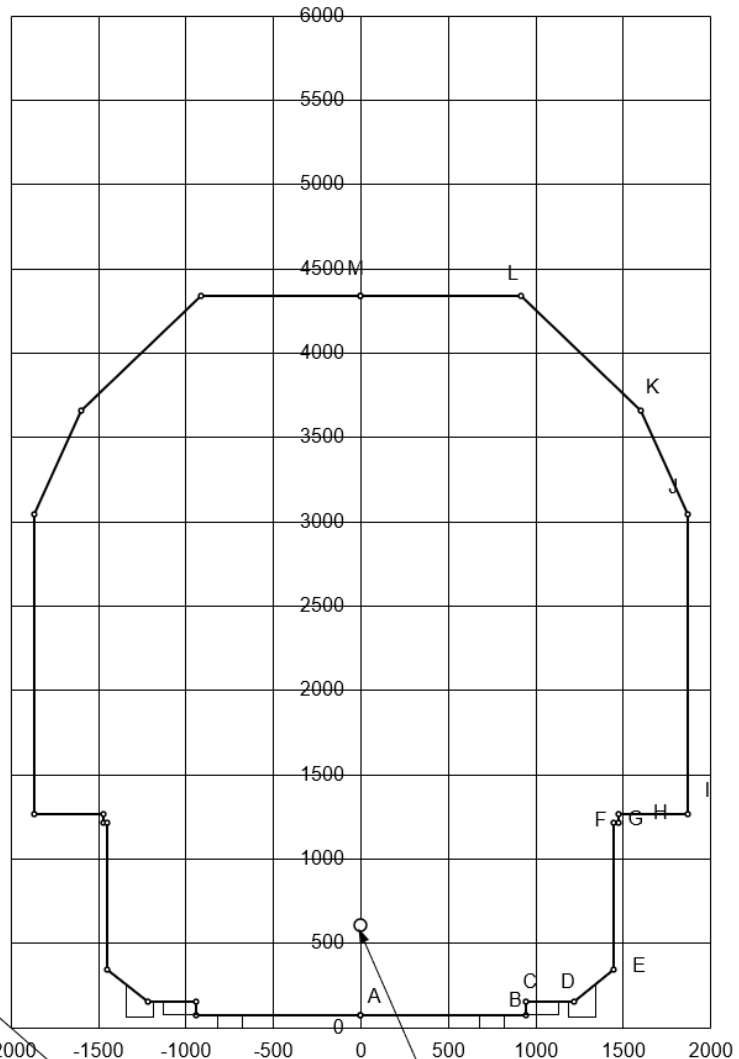

Physical Interface for wheels only.

Outline Extension for bogie components only.

Physical Interface for trip valve arm only.

Roll Centre at 610 mm.

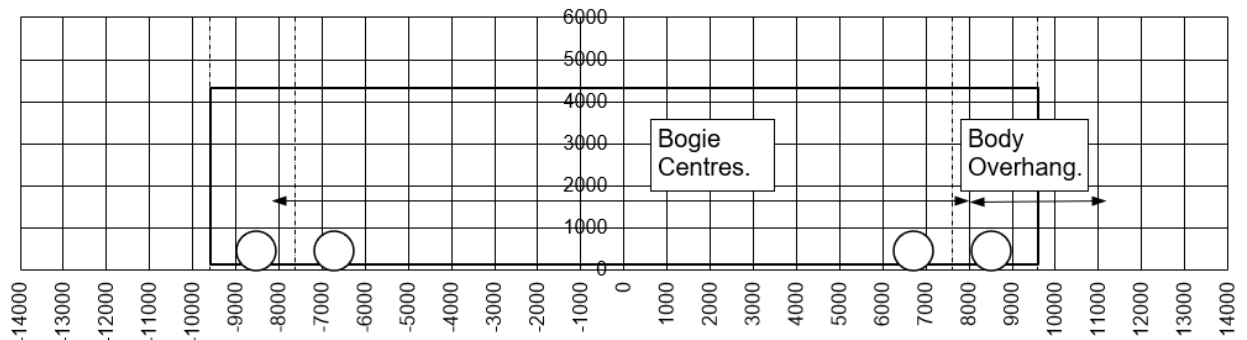

- All cross-section dimensions are symmetrical about the vehicle centreline.
- The origin for all horizontal coordinates is the vehicle centreline.
- The origin for all cross-section vertical coordinates is the rail level.
- All dimensions are in millimetres.

Figure 16 - Out of Gauge Load rolling stock outline dimensions

Bogie Centres: 18300 mm
Body Overhang: 0 mm

Coordinates

Point	Lateral	Vertical
A	0	102
B	838	102
C	838	178
D	1143	178
E	1397	381
F	1397	1220
G	1790	1220
H	1790	3048
I	1524	3658
J	838	4343
K	0	4343

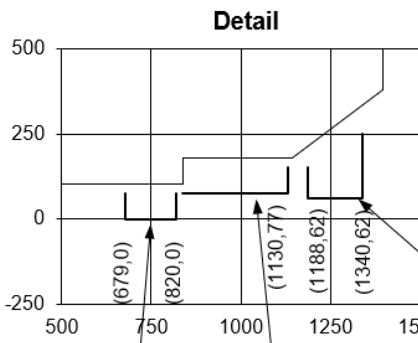
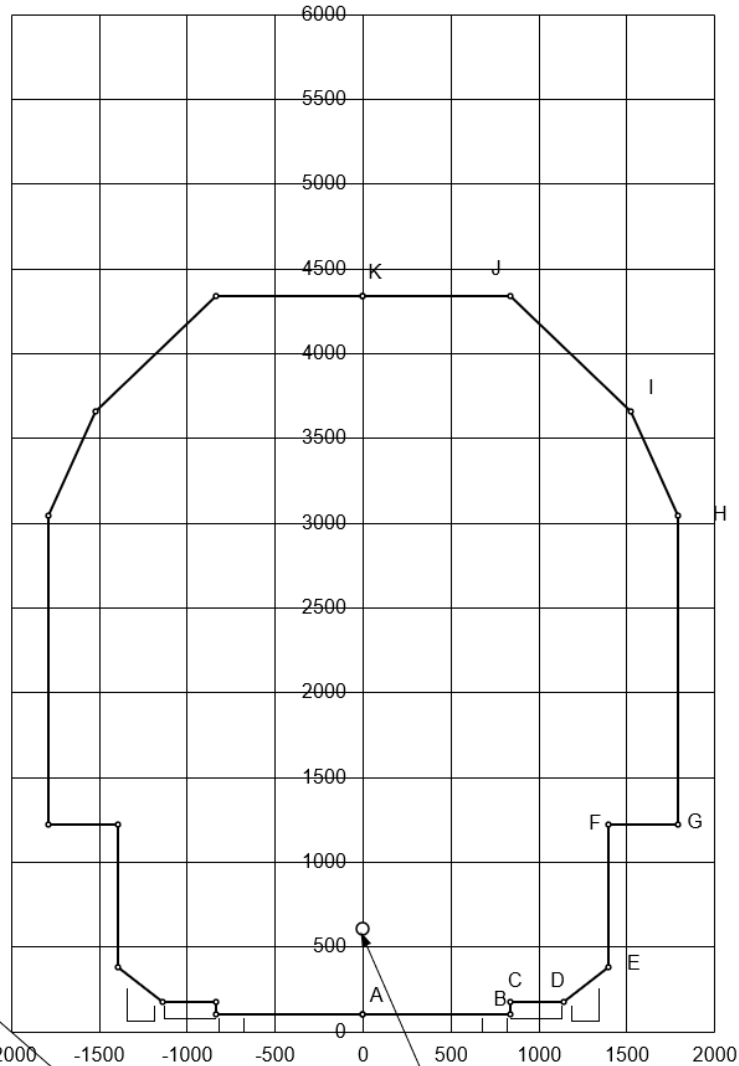

Physical Interface for wheels only.

Outline Extension for bogie components only.

Physical Interface for trip valve arm only.

Roll Centre at 610 mm.

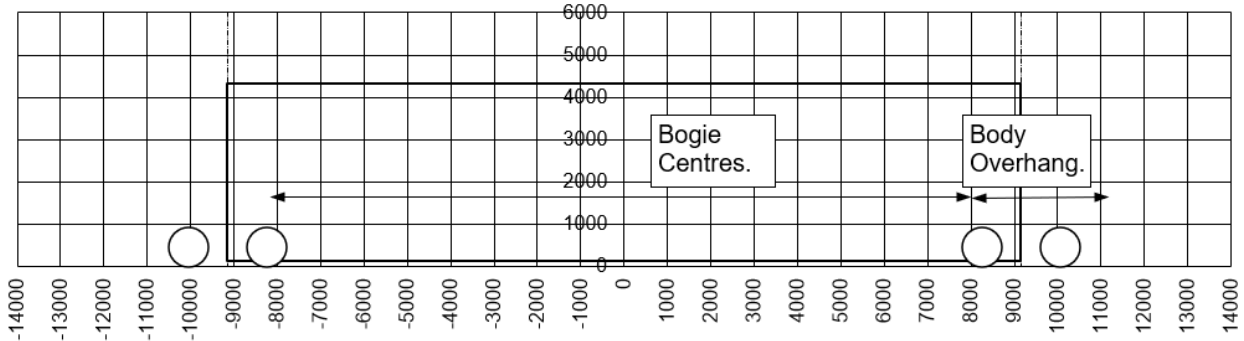

- All cross-section dimensions are symmetrical about the vehicle centreline.
- The origin for all horizontal coordinates is the vehicle centreline.
- The origin for all cross-section vertical coordinates is the rail level.
- All dimensions are in millimetres.

Figure 17 - NZZA Wagon rolling stock outline dimensions

Appendix 3 Definition of Symbols

Symbol	Description	Units
E_a	Design superelevation at the point in the track being analysed.	mm
E_{a_o}	Design superelevation of the track on the outside of a curve in dual track areas.	mm
E_{a_i}	Design superelevation of the track on the inside of a curve in dual track areas.	mm
E_{a_e}	Effective superelevation for the point in the track being analysed.	mm
R	Radius of the track at the point in the track being analysed.	m
R_e	Effective Radius of the track for the point in the track being analysed.	m
K	Co-efficient for determining horizontal displacement due to centre throw $\frac{B_c^2}{8}$	
k	Co-efficient for determining horizontal displacement due to superelevation $\frac{V}{1435}$	
B_c	Vehicle bogie centres.	mm
L	Vehicle length.	mm
V_c	Platform Height for a Concave Platform above design low rail level.	mm
V_v	Platform Height for a Convex Platform above design low rail level.	mm
V_s	Platform Height for a Platform above design low rail level.	mm
H_s	Platform Horizontal position for a Platform from design track centreline.	mm